

RESMED

S8 Escape™ II

POSITIVE AIRWAY PRESSURE DEVICE

User Guide

English

Contents

Introduction	1
Contraindications	1
Adverse Effects	1
The S8 Escape II System	2
Masks	2
Humidifiers	2
ResScan Data Card	2
Using the S8 Escape II	3
Set Up the S8 Escape II	3
Start Treatment	4
Stop Treatment	4
How to Use the Control Panel	5
How to Change the Settings on your S8 Escape II	6
Using the Data Card to Collect data	8
Cleaning and Maintenance	8
Daily	9
Weekly	9
Monthly	9
Replacing the Air Filter	9
Servicing	10
Frequently Asked Questions	10
Troubleshooting	11
Technical Specifications	13
General Warnings and Cautions	14
Limited Warranty	16

Introduction

The S8 Escape II continuous positive airway pressure (CPAP) system is indicated for the treatment of obstructive sleep apnea (OSA) in patients > 66lb (30 kg).

The S8 Escape II CPAP system is intended for home and hospital use.



CAUTION

In the US, Federal law restricts this device to sale by or on the order of a physician.

Contraindications

The S8 Escape II is not a life support device and may stop operating during power failure or certain fault conditions. It should not be used by patients who are dependent on continuous therapy.

Positive airway pressure therapy may be contraindicated in some patients with the following pre-existing conditions:

- severe bullous lung disease
- pneumothorax
- pathologically low blood pressure
- dehydration
- cerebrospinal fluid leak, recent cranial surgery, or trauma.

Adverse Effects

Patients should report unusual chest pain, severe headache, or increased breathlessness to their prescribing physician. An acute upper respiratory tract infection may require temporary discontinuation of treatment.

The following side effects may arise during the course of therapy with the CPAP device:

- drying of the nose, mouth, or throat
- nosebleed
- bloating
- ear or sinus discomfort
- eye irritation
- skin rashes.

The S8 Escape II System

Your S8 Escape II comprises:

- S8 Escape II positive airway pressure device
- 2 m air tubing
- Power cord
- Carry bag.

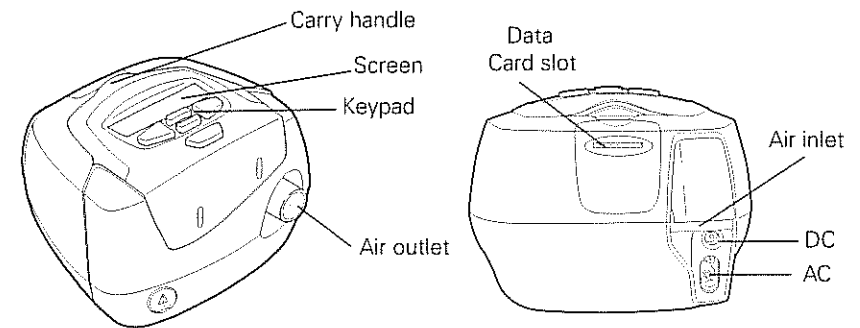

Optional components include:

- ResScan™ Data Card
- 3 m air tubing
- DC-12 converter.

Masks

For information on using masks, see your mask manual. Recommended masks are available on www.resmed.com on the **Products** page under **Service & Support**.



WARNING

Only ResMed mask systems are compatible for use with the S8 Escape II. Please refer to "Adverse Effects" on page 1.

Humidifiers

A list of humidifiers compatible with ResMed devices can be found on www.resmed.com, on the **Products** page under **Service & Support**.

ResScan Data Card

The ResScan Data Card may be used with the S8 Escape II either to help your clinician to monitor your treatment or to provide you with updates to your device settings.

Using the S8 Escape II

WARNING

- Make sure the power cord and plug are in good condition and the equipment is not damaged.
- Only ResMed air tubing should be used with the device. A different type of air tubing may alter the pressure you actually receive, reducing the effectiveness of your treatment.
- Blocking the hose and/or air inlet of the device while in operation could lead to overheating of the device.

CAUTION

- Be careful not to place the device where it can be bumped or where someone is likely to trip over the power cord.
- If you put the device on the floor, make sure the area is free from dust and clear of bedding, clothes or other objects that could block the air inlet.
- Make sure the area around the device is dry and clean.

Set Up the S8 Escape II

- 1 Connect the power cord to the socket at the rear of the S8 Escape II.
- 2 Plug the other end of the power cord into the power outlet.
- 3 Connect one end of the air tubing firmly onto the air outlet.
- 4 Connect the assembled mask system to the free end of air tubing. For information on assembling your mask, see your mask manual.

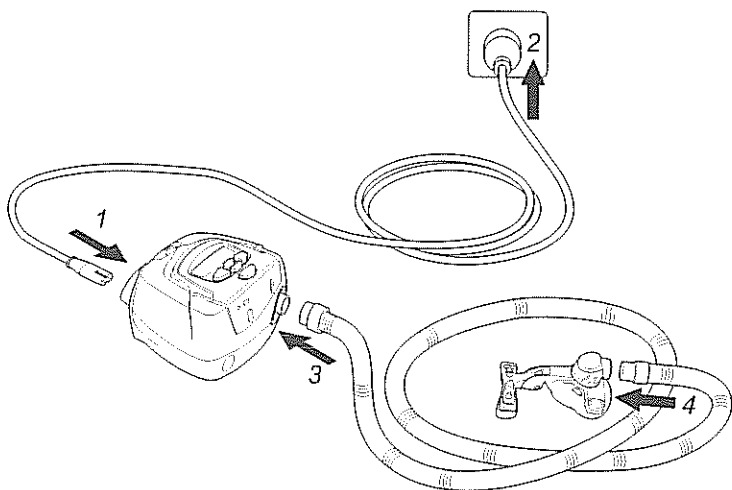

Start Treatment

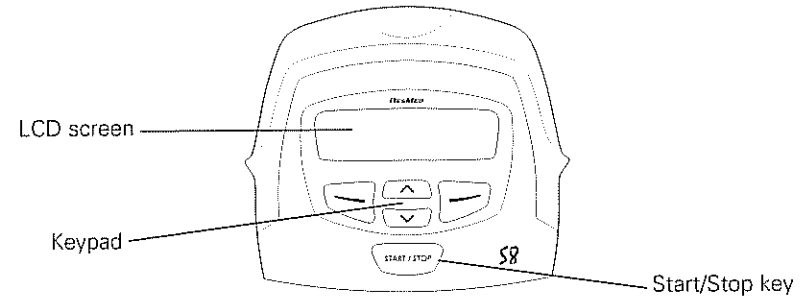

- 1** Make sure the power is on.
The product name is displayed briefly on the LCD screen, then the standby (Ramp) screen appears. The key and LCD backlights also turn on.
- 2** Lie down and arrange the air tubing so that it is free to move if you turn in your sleep.

CAUTION
Do not leave long lengths of air tubing around the top of your bed. They could twist around your head or neck while you are sleeping.

- 3** Alter the ramp time if required (see "How to change the ramp time" on page 6).
- 4** To start treatment, press .
- 5** Fit your mask as described in the mask user instructions.

WARNING
A mask should not be used unless the S8 Escape II device is turned on and operating properly.

When ramping begins the LCD will display the word "RAMPING", with the current pressure indicated as dashes. Each dash is approximately equivalent to 2 cm H₂O. For example, 6 dashes represents approximately 12 cm H₂O pressure.





Stop Treatment

To stop treatment at any time, remove your mask and press .

How to Use the Control Panel

The control panel of the S8 Escape II includes an LCD screen which displays the menus and treatment screens as well as a keypad for navigating through the menus and delivering treatment.

The S8 Escape II keypad has the following keys:

Key	Function
Start/Stop 	Starts or stops treatment.
Up 	Allows you to increase settings options and scroll through the S8 Escape II menu.
Down 	Allows you to decrease settings options and scroll through the S8 Escape II menu.
Left 	Performs the function indicated by the guiding text displayed above it on the LCD screen. Guiding text includes menu , change , and apply .
Right 	Performs the function indicated by the guiding text displayed above it on the LCD screen. Guiding text includes exit and cancel .

The keypad and LCD are equipped with backlights that come on when the device is powered. The LCD backlight turns off after two minutes of inactivity, and comes back on when you press a key. The keypad backlight is always on while the S8 Escape II is on.

How to Change the Settings on your S8 Escape II

You can change settings (such as Ramp Time) on the S8 Escape II by using the keypad and LCD. When the S8 Escape II is in standby mode you can display a series of screens (a menu) on the LCD screen in order to view and change the settings for a particular function.

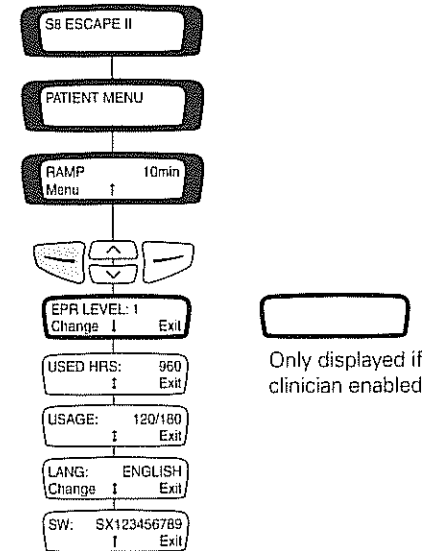

Use the menu screens to change the ramp time and language. You can also view details about the usage and software version of your S8 Escape II.







How to change the ramp time

During ramp time, the pressure increases from a low pressure to the prescribed treatment pressure. You can set the ramp time in 5-minute intervals, from 0 minutes (OFF) up to a maximum ramp time set by your clinician. The standby screen displays the current ramp time in the right corner.







1. Press or until the desired ramp time appears.
2. Once a ramp time is selected, begin therapy by pressing . When ramping begins the LCD will display the word "RAMPING", with the current pressure indicated as dashes. Each dash is approximately equivalent to 2 cm H₂O. For example, six dashes represents approximately 12 cm H₂O pressure.

How to change the EPR level

EPR can be used to help ease any discomfort you may experience when breathing out during treatment. If your clinician has allowed access you can change the EPR level. There are four settings: OFF; 1 (lowest EPR); 2; and 3 (highest EPR).

1. On the standby (RAMP) screen, press .
2. Press  until you see EPR LEVEL, then press  (Change).
3. Press  or  until you see the setting that you require.
4. Press  (Apply) to save the setting.

How to change the language setting





1. On the standby (Ramp) screen, press  (Menu).
2. Press  until you see LANG (Language), then press  (Change).
3. Press  or  until you see the language that you require.
4. Press  (Apply) to save the new language.

Messages on the S8 Escape II LCD

Your clinician may have set your S8 Escape II to remind you about important events, such as when to replace your mask, when to insert your Data Card (if your device is Data Card enabled) and so on.

The reminder message is displayed on the LCD and is visible if the device is not delivering therapy. The backlight on the LCD flashes when a message is displayed.

Your clinician can set any of the following reminders on your LCD:

Message	Description	Action
INSERT CARD	May appear if your device is Data Card enabled.	Insert your Data Card and follow any instructions that your clinician has given you. When you have done this, the message will disappear from the LCD. Pressing  (Ok) will also remove the message.
REPLACE MASK	May appear when your mask is due for replacement.	Press  (Ok) to remove the message from your LCD, and replace your mask with a new one.
CALL PROVIDER	May appear as a reminder to contact your clinician, eg, to discuss how your therapy is going.	Press  (Ok) to remove the message from your LCD, and contact your clinician.
REPLACE FILTER	May appear as a reminder to replace the air filter on your device.	Press  (Ok) to remove the message from your LCD, and replace the air filter.
SERVICE DUE	May appear as a reminder to return your device for service.	Press  (Ok) to remove the message from your LCD, and contact your clinician.

Using the Data Card to Collect data

If your clinician needs to review your treatment, they will ask you to use the Data Card to copy data from your S8 Escape II, and to return the card to them. The Data Card will be provided in a protective folder.

Data that is copied to a Data Card is still stored and available on the S8 Escape II.

Copy data onto the Data Card

1. Switch on the S8 Escape II and wait until you see the standby (Ramp) screen.
2. Hold the Data Card with the arrow facing up and insert it into the Data Card slot until it stops. Data copying starts automatically.
The "Card Inserted Please Wait" message is displayed on the S8 Escape II LCD while data is being copied. Copying takes approximately five seconds.
The "Copy Complete Remove Card" message is displayed on the LCD when copying has finished.
3. Remove the Data Card by gripping the end of the Data Card and pulling it out.
4. Store the Data Card in its protective folder when not in use.
5. Return the card in its protective folder to your clinician using a postal envelope.

Using the Data Card to Update Settings

If your clinician has provided a Data Card with new device settings:

1. With the device in standby (Ramp) mode, insert the Data Card into the slot on the Data Card module. Updating will start automatically.
The "Card Inserted Please Wait" message is displayed on the LCD while updating is in progress. Updating takes approximately five seconds.
The "Settings Success Remove Card" message is displayed on the LCD if the settings were updated successfully.
Note: *This message only appears once. If you re-insert the Data Card after you have updated your settings, this message is not displayed.*
2. Remove the Data Card from the S8 Escape II.
3. Store the Data Card in its protective folder when not in use.



WARNING

If your clinician has told you to use this Data Card to update the settings on your device and the "Settings Success" message does not appear, contact your clinician immediately.

Cleaning and Maintenance



WARNING

Beware of electric shock. Do not immerse the unit or power cord in water. Always unplug the unit before cleaning and be sure it is dry before plugging back in.

CAUTION

- Do not hang the air tubing in direct sunlight as it may harden over time and eventually crack.
- Do not use bleach, chlorine, alcohol, or aromatic-based solutions, moisturising or antibacterial soaps or scented oils to clean the air tubing or the S8 Escape II. These solutions may cause hardening and reduce the life of the product.

Daily

Disconnect the air tubing and hang it in a clean, dry place until next use.

Weekly

1. Remove the air tubing from the S8 Escape II *and* the mask.
2. Wash the air tubing in warm water using mild detergent.
3. Rinse thoroughly, hang, and allow to dry.
4. Before next use, reconnect the air tubing to the air outlet and mask.

Monthly

1. Clean the exterior of the S8 Escape II with a damp cloth and mild liquid soap.
2. Check the air filter for holes and blockage by dirt or dust. Replace it every six months, or more often in a dusty environment (see "Replacing the Air Filter" on page 9).

Replacing the Air Filter**WARNING**

- Do not wash the air filter. The air filter is not washable or reusable.
- The air filter cover protects the device in the event of accidental liquid spillage onto the device. Ensure the air filter and air filter cover are fitted at all times.

1. Remove the air filter cover at the back of the S8 Escape II.

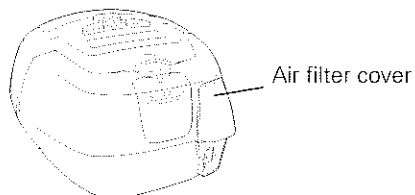

2. Remove and discard the old air filter.
3. Insert a new filter with the blue tinted side facing out from the device.
4. Replace the air filter cover.

Servicing



CAUTION

- Do not attempt to open the S8 Escape II case. There are no user serviceable parts inside.
- Inspection and repair should only be performed by an authorized agent. Under no circumstances should you attempt to service or repair the S8 Escape II yourself.

This product (S8 Escape II) should be inspected by an authorized ResMed Service Center five years from the date of manufacture. Prior to this, the device is intended to provide safe and reliable operation provided that it is operated and maintained in accordance with the instructions provided by ResMed. Applicable ResMed warranty details are provided with the device at the time of original supply. Of course, as with all electrical devices, if any irregularity becomes apparent, you should exercise caution and have the device inspected by an Authorized ResMed Service Center.

If you feel that your device is not performing properly, see “Troubleshooting” on page 11.

Frequently Asked Questions

How will it feel when I am breathing with the S8 Escape II?

When you first use your S8 Escape II, you may feel uncomfortable breathing against the airflow. This is normal. You will continue to breathe normally while you sleep. The EPR setting may also improve comfort. Take time to adjust to this new sensation.

What do I do when I want to get up in the night?

If you need to get up during the night, remove your mask and stop therapy. Always remember to restart therapy and put your mask on when you return to bed.

What do I do if I feel air leaking out of the mask?

The S8 Escape II delivers the most effective treatment when the mask is well fitted and comfortable. Treatment can be affected by leaks, so it is important to eliminate any leaks that may arise. For example, try repositioning the mask and adjusting the straps.

If you are using a nasal mask, try to keep your mouth closed during treatment. Air leaks from your mouth can decrease the effectiveness of your treatment. If mouth leaks are a problem, a full face mask or chin strap may help. Contact your clinician or equipment supplier for further details.

If you are using a full face mask and you have problems trying to get a comfortable mask fit, contact your clinician or equipment supplier. You may benefit from a different size or style of mask.

Anything special I should do before putting the mask on?

Before wearing your mask, wash your face to remove excess facial oils. This will allow a better fit and prolong the life of the mask cushion.

Do not use moisturizer when wearing a mask.

My mouth feels dry during treatment—what can I do?

You may experience dryness of the nose, mouth, and/or throat during the course of treatment, especially during winter. In many cases, a humidifier may resolve this discomfort. Contact your clinician for advice.

My nose is irritated during treatment—what can I do?

You may experience sneezing and/or a runny or blocked nose during the first few weeks of treatment. In many cases, nasal irritation can be resolved with a humidifier. Consult your clinician or equipment supplier for advice.

Can I travel with the S8 Escape II?

Your S8 Escape II has an internal power supply that enables it to operate in other countries. It will operate on power supplies of 100–240V and 50/60Hz. No special adjustment is necessary, but you will require an approved power cord for the region in which you are using the device.

Please consult the medical services department of your carrier if you intend to use your S8 Escape II on an aircraft. The S8 Escape II complies with US FCC Part 15, Class B requirements.

Note: Do not use your S8 Escape II while the aircraft is taking off or landing.

Can I use my S8 Escape II if mains (AC) power is not available?

A DC-12 converter is available to connect the S8 Escape II to a 12V or 24V DC power source. Contact your clinician for details.

**CAUTION**

The device should not be connected to both AC and DC power sources simultaneously.

Troubleshooting

If there is a problem, try the following suggestions. If the problem cannot be solved, contact your equipment supplier or ResMed. Do not attempt to open the device.

Problem/Possible Cause	Solution
No display	
Power is not connected.	Ensure the power cable is connected and the power switch (if available) is on.
Displays error message: Exxxxx Call Service (where xxxxx defines an error) or MOTOR FAULT Call Service or UPLOAD LANGUAGES Call Service or DATA LOST Call Service	
Component failure.	Call service.

Insufficient air delivered from S8 Escape II

Ramp Time is in use.	Wait for air pressure to build up or change ramp time.
Air filter is dirty.	Replace air filter.
Air tubing is kinked or punctured.	Straighten or replace tubing.
Air tubing is not connected properly.	Check air tubing.
Mask and headgear are not positioned correctly.	Adjust position of mask and headgear.
Cap(s) are missing from access port on mask.	Replace cap(s).
Pressure required for treatment may have changed.	See your clinician to adjust the pressure.

The following message is displayed on the LCD after you try to update settings or copy data to the Data Card: Card Error Remove Card

Data Card is not inserted correctly.	Check that the patient is inserting the Data Card into the Data Card module with the arrow facing up, while the S8 Escape II is switched on and not delivering therapy (standby mode).
The Data Card is only partly inserted.	Ensure that the Data Card is inserted into the Data Card slot as far as it will go.
You may have removed the Data Card before settings were copied to the S8 Escape II.	Reinsert the Data Card and wait for the Settings Success Remove Card message to appear on the LCD.
The card is not a ResScan Data Card.	Only use a ResScan Data Card.

The following message is displayed on the LCD after you try to update settings or copy data to the Data Card: Settings Invalid Remove Card

The identification details on the Data Card do not match the identification details on your device.	Contact your clinician immediately.
-----------------------------------------------------------------------------------------------------	-------------------------------------

The following message is displayed on the LCD after you try to update settings or copy data to the Data Card: Settings Error Remove Card

There is a data error on the Data Card.	Contact your clinician immediately.
-----------------------------------------	-------------------------------------

The following message is NOT displayed on the LCD after you try to update the settings using the Data Card: Settings Success Remove Card







The settings were not updated.	Contact your clinician immediately.
--------------------------------	-------------------------------------

Technical Specifications

Operating pressure range	4 to 20 cm H ₂ O
Dimensions (H x W x D)	4.6" x 6.5" x 5.7" (112 mm x 164 mm x 145 mm)
Weight	2.9lb (1.3 kg)
Power Supply	<ul style="list-style-type: none"> • Input range for S8 Escape II with HumidAire 3i: 100–240V, 50/60Hz; 110V, 400Hz; 2.5A < 140VA (110W) (maximum power consumption). Instantaneous peak power consumption <340VA. • Refer to the DC-12 converter instructions for DC ratings. Only use the ResMed DC-12 converter for DC input. • Typical power consumption at 20 cm H₂O is 34VA or 20W.
Air Filter	Two-layered, powder-bonded, polyester non-woven fiber
Air Tubing	Flexible plastic, 6'6" (2 m)
Air Outlet	The 22 mm conical outlet complies with EN 1281-1
IEC 60601-1 Classifications	Class II (double insulation), Type CF
Noise Level	Radiated sound pressure is measured at <30dBA at 10 cm H ₂ O and 3'3.36" (1 m) according to ISO17510-1.
Supplemental Oxygen	Recommended maximum supplemental oxygen flow: 4 L/min
Housing Construction	Flame retardant engineering thermoplastic
Operating Temperature	+41°F to +95°F (+5°C to +35°C)
Operating Humidity	10%–95% non-condensing
Storage and Transport Temperature	-4°F to +140°F (-20°C to +60°C)
Storage and Transport Humidity	10%–95% non-condensing
Operating Altitude	Sea level to 8500' (2591 m)
Electromagnetic Compatibility	<p>Product complies with all applicable electromagnetic compatibility requirements (EMC) according to IEC60601-1-2, for residential, commercial, and light industry environments.</p> <p>The electromagnetic compatibility tables for these ResMed devices can be found on www.resmed.com, on the Products page under Service & Support. Click on the PDF file for your device.</p>

Note: The manufacturer reserves the right to change these specifications without notice.

Symbols which appear on the device

 Attention, consult accompanying documents;
  Drip proof;
  Type CF equipment;
  Dangerous voltage;
  Class II equipment;
  Start/Stop.

General Warnings and Cautions

Warnings

- Read the entire guide before using the S8 Escape II.
- Advice contained in this guide should not supersede instructions given by the prescribing physician.
- A patient should not connect a device to the data communication port unless instructed to do so by their health care provider or physician. Only ResMed products are designed to be connected to the data communication port. Connecting other devices could result in injury, or damage to the S8 Escape II device.
- The S8 Escape II should be used with masks (and connectors)* recommended by ResMed, or by a physician or respiratory therapist. A mask should not be used unless the S8 Escape II device is turned on and operating properly. The vent hole or holes associated with the mask should never be blocked.

Explanation: The S8 Escape II is intended to be used with special masks (or connectors)* which have vent holes to allow continuous flow of air out of the mask. When the device is turned on and functioning properly, new air from the device flushes the exhaled air out through the mask vent holes. However, when the device is not operating, insufficient fresh air will be provided through the mask, and the exhaled air may be rebreathed. Rebreathing of exhaled air for longer than several minutes can, in some circumstances, lead to suffocation. This applies to most models of CPAP devices.

- In the event of power failure or machine malfunction, remove the mask.
- The S8 Escape II can be set to deliver pressures up to 20 cm H₂O. In the unlikely event of certain fault conditions, pressures up to 30 cm H₂O are possible.
- If oxygen is used with this device, the oxygen flow must be turned off when the device is not operating.
If the oxygen has been left on, turn off the device, then wait 30 minutes before turning on the device again.

Explanation: When the CPAP device is not in operation and the oxygen flow is left on, oxygen delivered into the air delivery tubing may accumulate within the CPAP machine enclosure and create a risk of fire. This applies to most types of CPAP machines.

- Oxygen supports combustion. Oxygen should not be used while you are smoking or in the presence of an open flame.
- Always ensure airflow is being generated by the device before the oxygen supply is turned on.
- Always turn the oxygen supply off before stopping the airflow from the device.

* Ports may be incorporated into the mask or in connectors that are near the mask.

Note: At a fixed rate of supplemental oxygen flow, the inhaled oxygen concentration will vary, depending on where the oxygen is introduced, the pressure settings, patient breathing pattern, mask selection, and leak rate.

- Do not use the S8 Escape II if there are obvious external defects or unexplained changes in performance.
- Do not open the S8 Escape II case. There are no user serviceable parts inside. Repairs and internal servicing should only be performed by an authorized service agent.
- Explosion hazard—do not use in the vicinity of flammable anesthetics.

Cautions

- At low pressures, the flow through the exhalation ports of your mask may not clear all exhaled gas from the tubing. Some rebreathing may occur.
- The airflow for breathing produced by this device can be as much as 11°F (6°C) higher than the temperature of the room. Caution should be exercised if the room temperature is warmer than 90°F (32°C).
- When AC mains power (100–240V AC) is not available, always use a ResMed DC-12 converter. (The DC-12 converter is available as an optional accessory. It is not supplied with all models.)

Note: The above are general warnings and cautions. Specific warnings, cautions, and notes appear with the relevant instructions in the manual.

Limited Warranty

ResMed warrants that your ResMed product shall be free from defects in material and workmanship for the period specified below from the date of purchase by the initial consumer. This warranty is not transferable.

Product	Warranty Period
ResMed humidifiers, ResControl™, ResLink™, ResTraxx™	1 Year
ResMed flow generators	2 Years
Accessories, mask systems (including mask frame, cushion, headgear and tubing). Excludes single-use devices.	90 Days

Note: Some models are not available in all regions.

If the product fails under conditions of normal use, ResMed will repair or replace, at its option, the defective product or any of its components. This Limited Warranty does not cover:

- a) any damage caused as a result of improper use, abuse, modification or alteration of the product;
- b) repairs carried out by any service organization that has not been expressly authorized by ResMed to perform such repairs;
- c) any damage or contamination due to cigarette, pipe, cigar or other smoke;
- d) any damage caused by water being spilled on or into a flow generator.

Warranty is void on product sold, or resold, outside the region of original purchase.

Warranty claims on defective product must be made by the initial consumer at the point of purchase.

This warranty is in lieu of all other express or implied warranties, including any implied warranty of merchantability or fitness for a particular purpose. Some regions or states do not allow limitations on how long an implied warranty lasts, so the above limitation may not apply to you.

ResMed shall not be responsible for any incidental or consequential damages claimed to have occurred as a result of the sale, installation or use of any ResMed product. Some regions or states do not allow the exclusion or limitation of incidental or consequential damages, so the above limitation may not apply to you. This warranty gives you specific legal rights, and you may also have other rights which vary from region to region.

For further information on your warranty rights, contact your local ResMed dealer or ResMed office.

R001-307/2 05 06